

± Ø165mm

Image shown above 28.9a.2, 500mm extender, with pendant anchor kit

Mounting	Ceiling mounted
Glass Colours	Clear, various colours
Lamp	1.5W LED, 2500K, 130lm
Extenders	Available in 150mm, 250mm, 500mm, 1200mm, 750mm (attached with 2 pendants). Up to 2500mm drop
Finish	Black powder coated
Materials	Blown glass, black powder coated stainless steel armature, electrical components, matte black canopy
Power Supply	Integral Bocci recommends remote mounting power supplies for ease of long-term maintenance.
Environment	Indoor, dry location. IP20
Note	Pendant anchor kit included. Every single Bocci product is handmade. They are blown, poured, carved, polished, packed and dispatched directly by us. As such, no two products are identical; they are individual, irregular expressions of our research.
Patent #	CAN 134238 US D687,740 EU 001695834-001 to 004

Weight (kg)	
28.5a.1	9.4
28.8a.1	14.4
28.8a.2	16.1
28.9a.1	16.5
28.9a.2	14.6
28.11a.1	21.7
28.11a.2	20.3
28.13a.1	23.7
28.17a.1	29.5
28.20a.1	35.1
28.23a.1	41.9
28.33a.1	59.1

Certifications

Each product is unique, there may be a variance in the weight up to 10%.

28.5A.1

All dimensions are in millimeters (mm) unless otherwise specified.

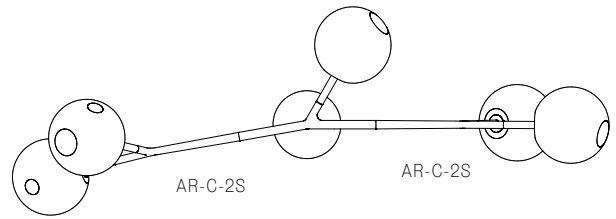
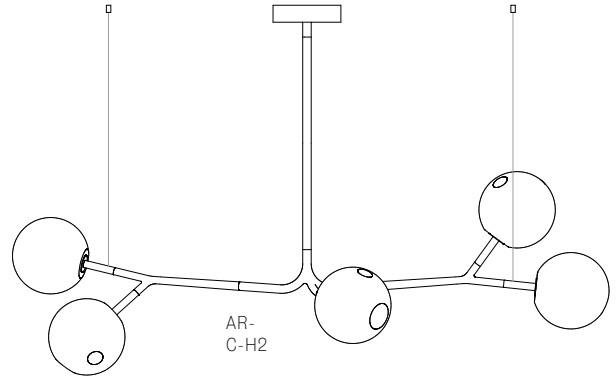
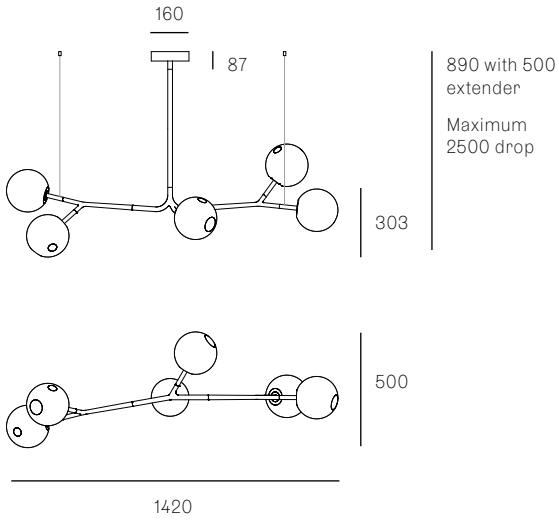

28.8A.1

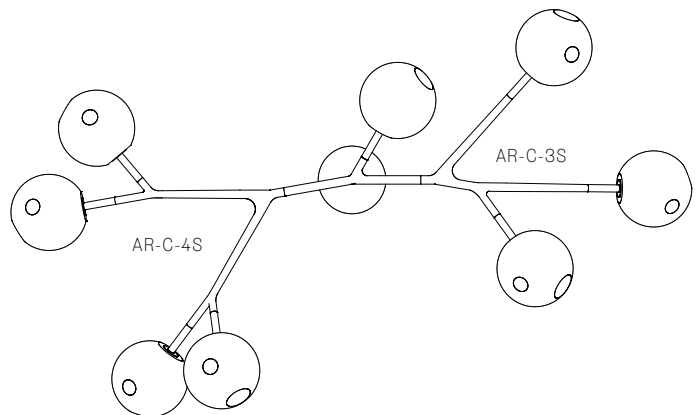
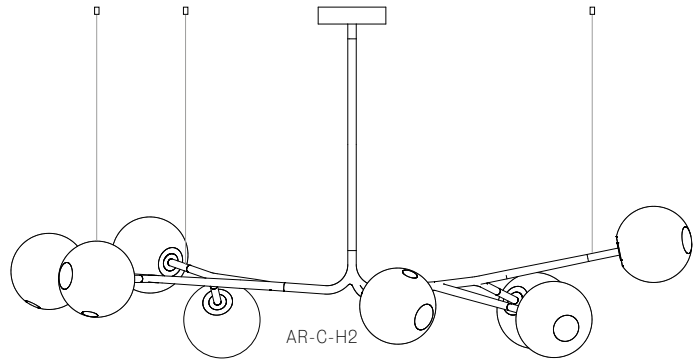
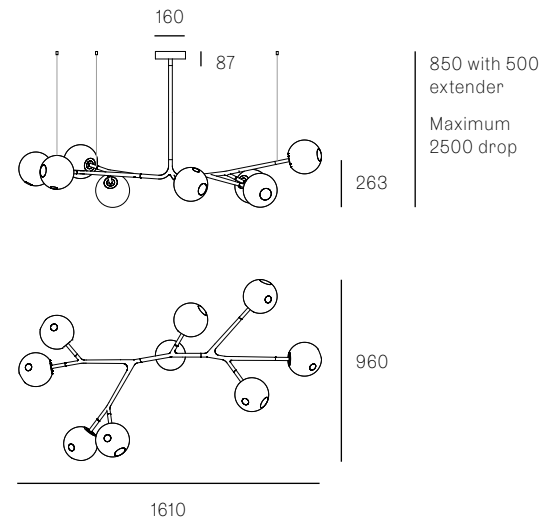

28.8A.2

All dimensions are in millimeters (mm) unless otherwise specified.

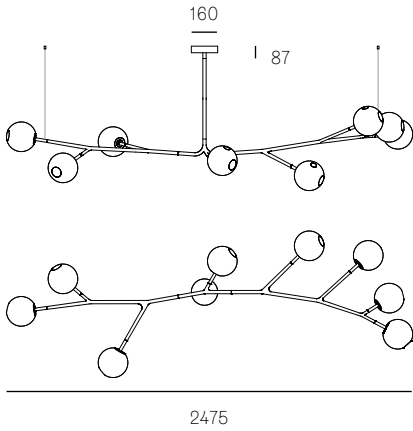

900 with 500 extender
Maximum 2500 drop
313
905

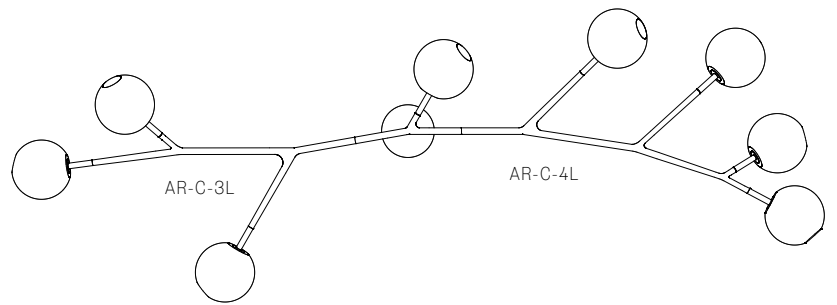
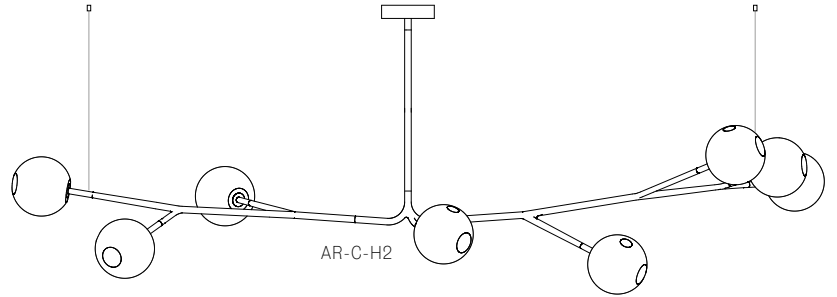

28.9A.1

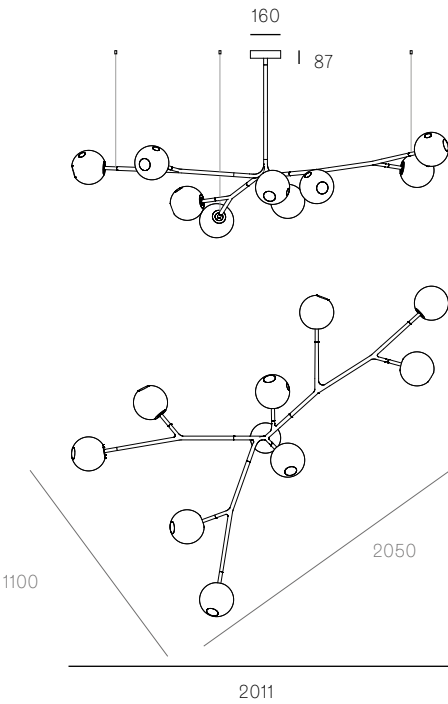

1047 with 500 extender
Maximum 2500 drop
1732

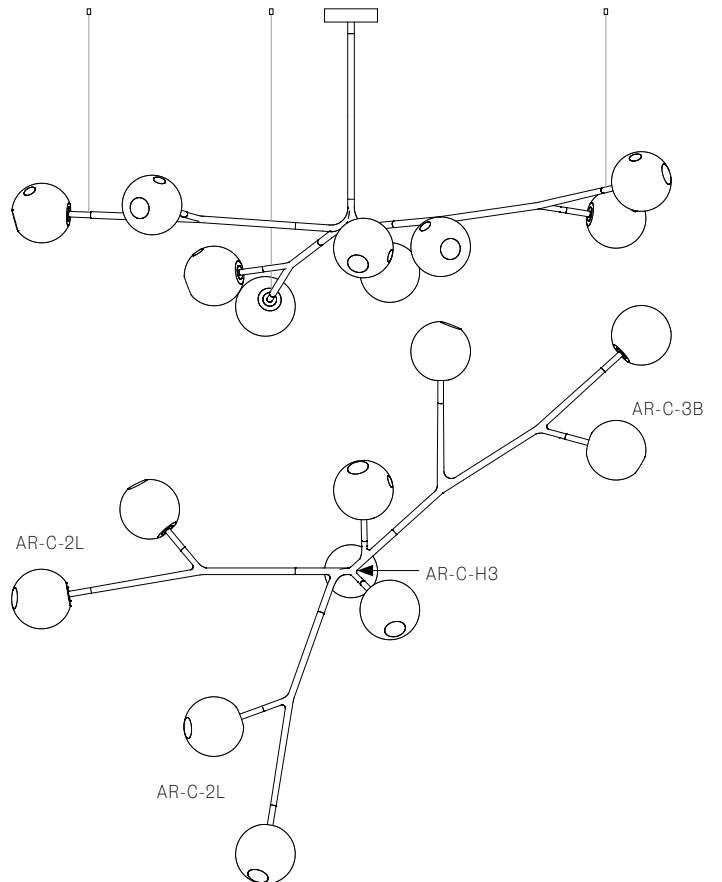

28.9A.2

All dimensions are in millimeters (mm) unless otherwise specified.

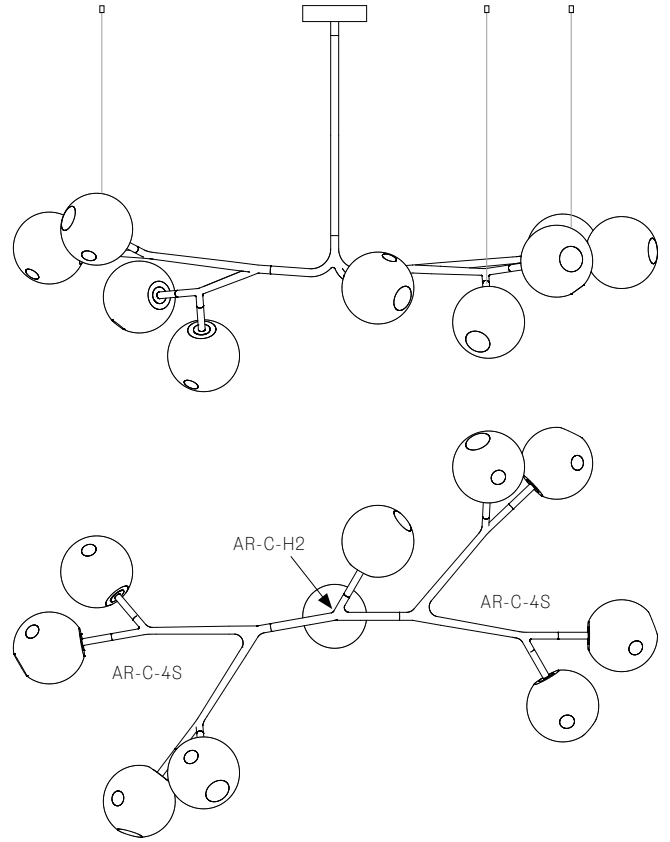
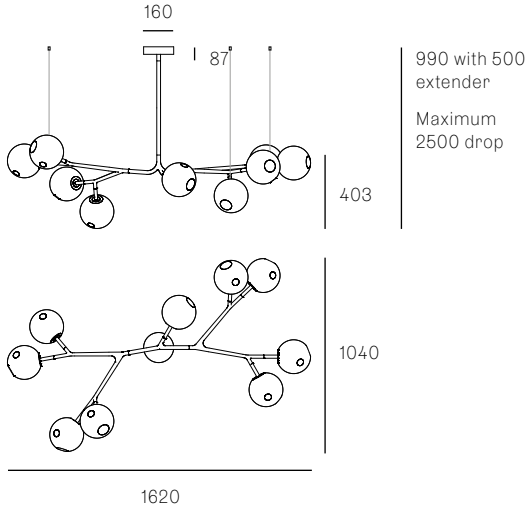

28.11A.1

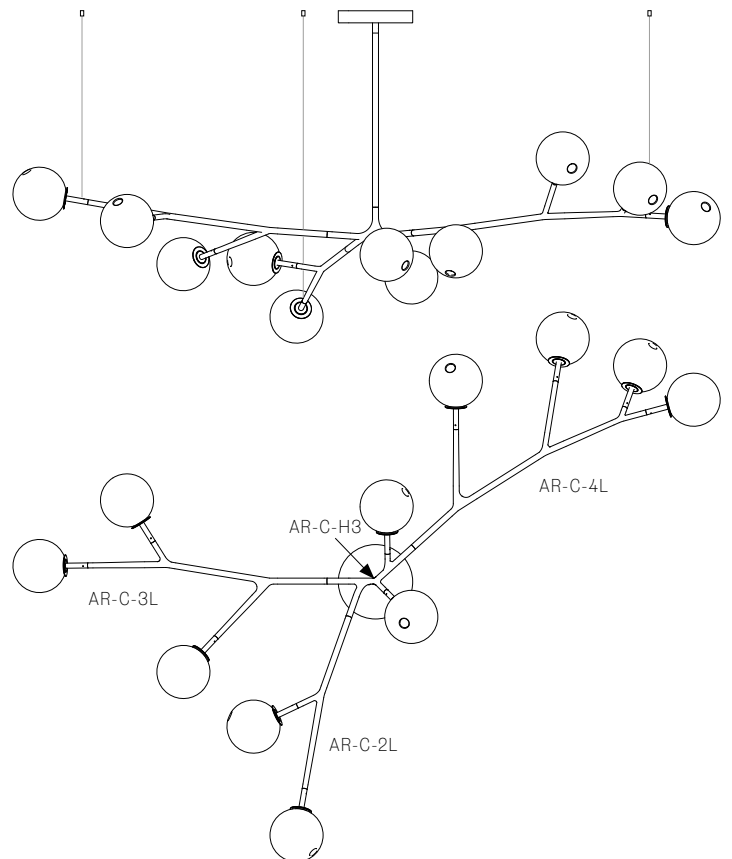
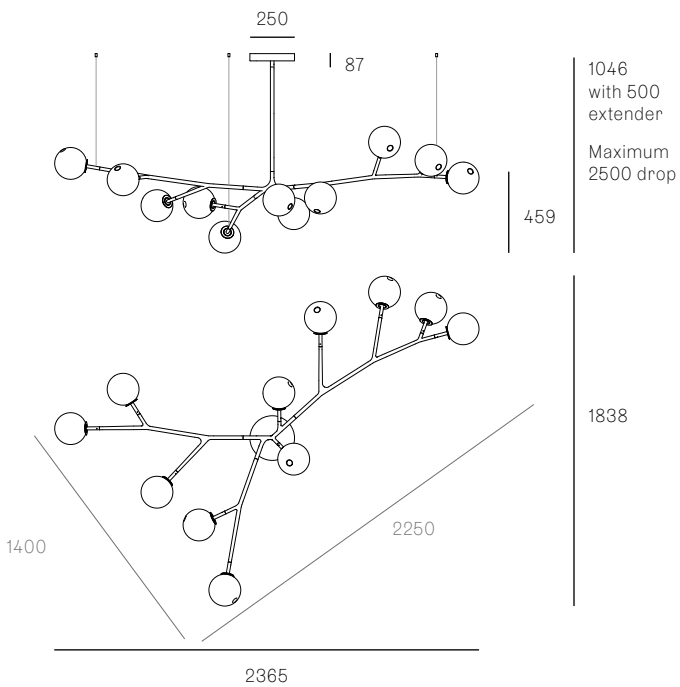

28.11A.2

All dimensions are in millimeters (mm) unless otherwise specified.

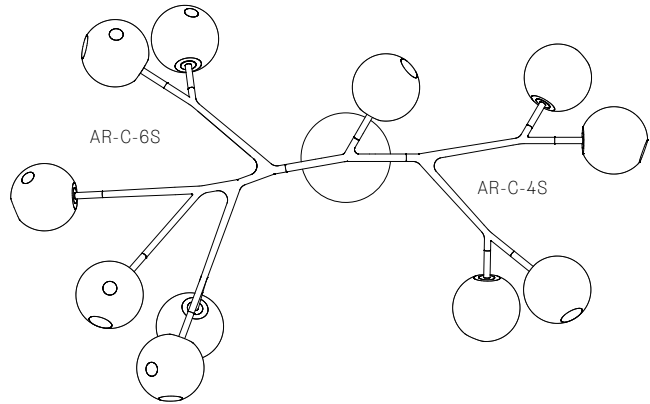
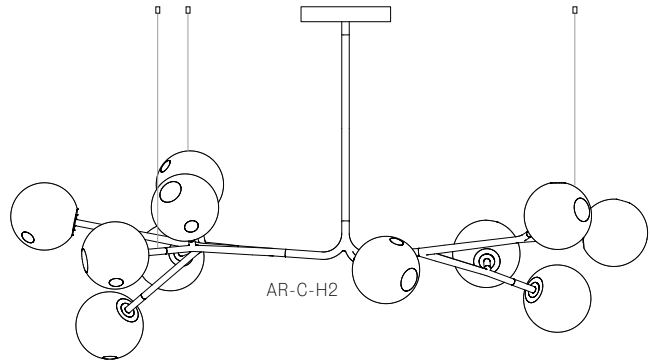
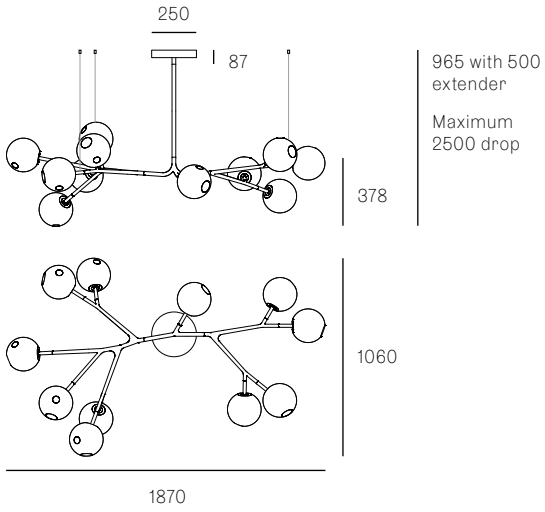

28.13A.1

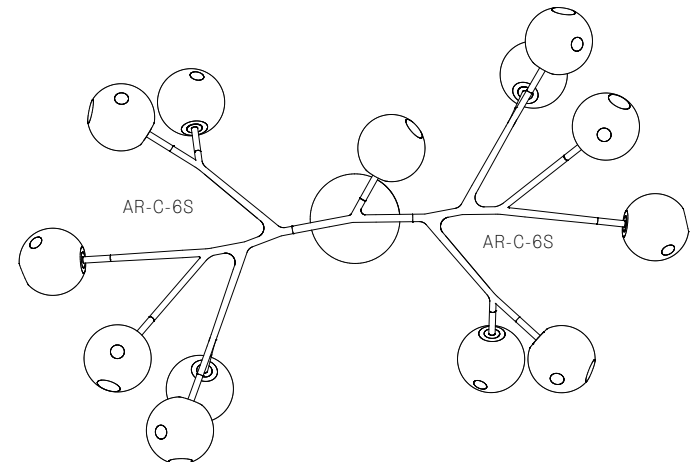
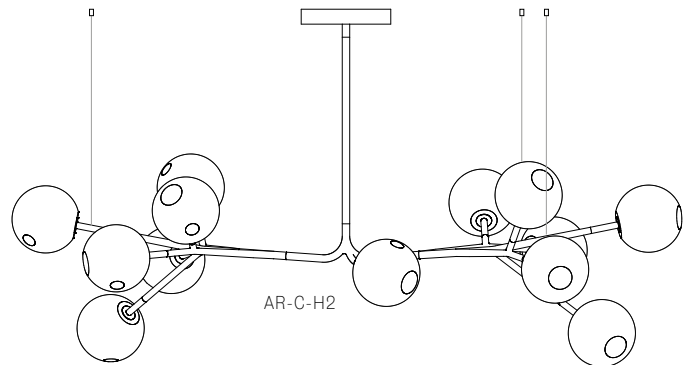
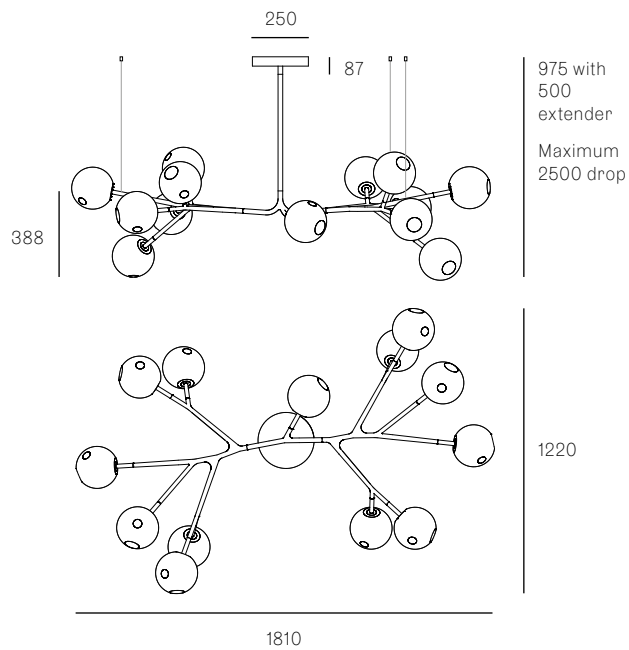

28.17A.1

All dimensions are in millimeters (mm) unless otherwise specified.

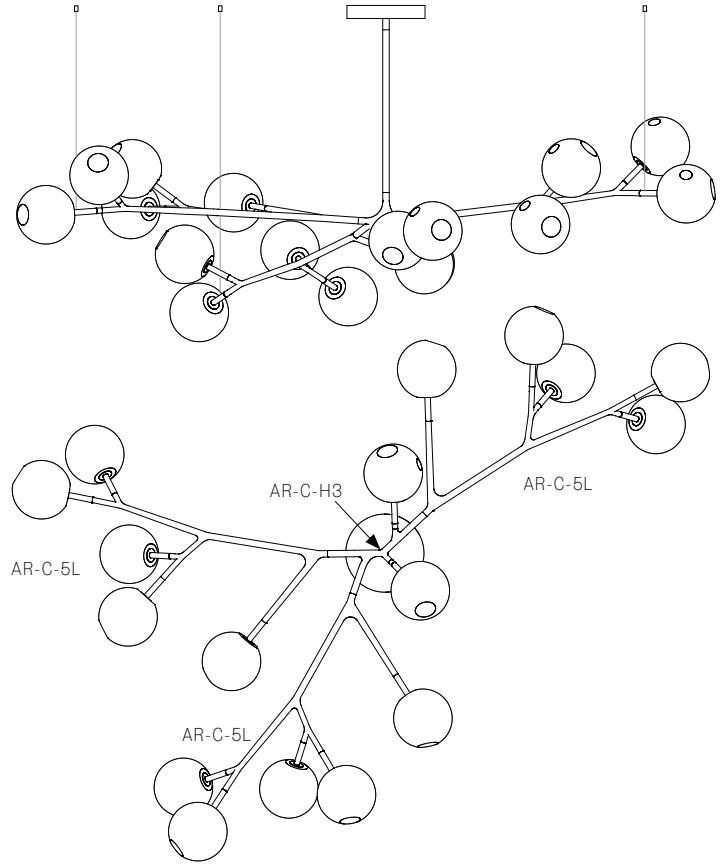
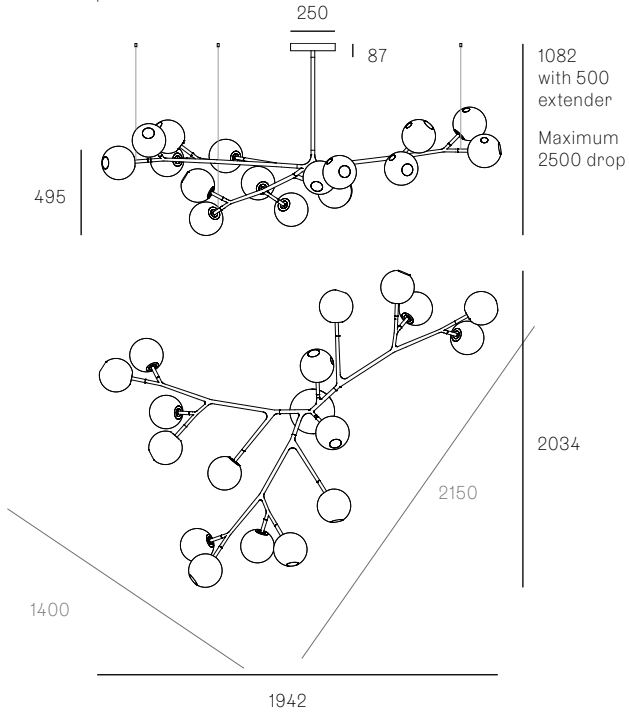

28.20A.1

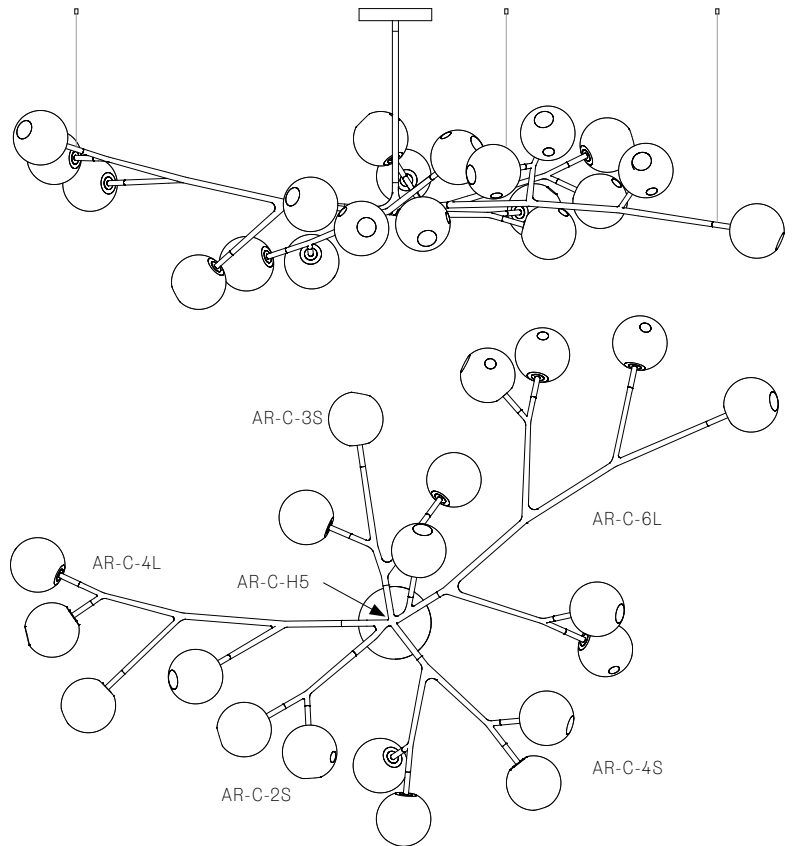
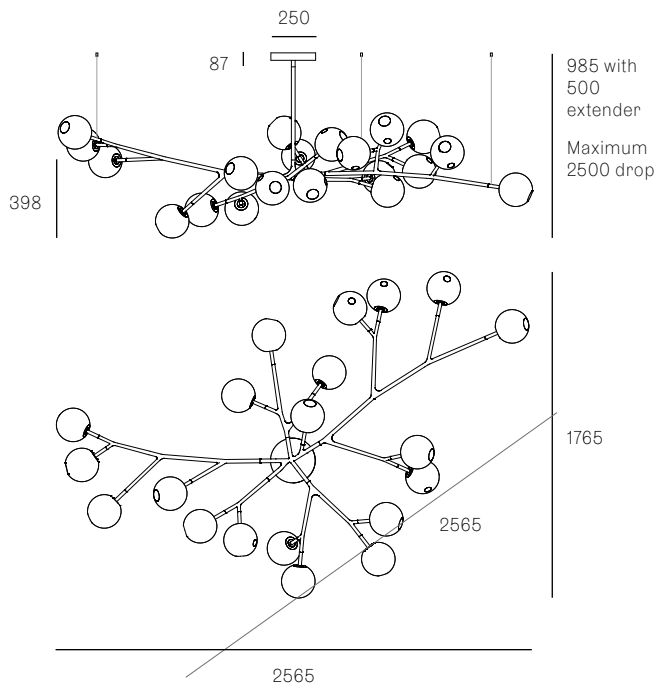

28.23A.1

All dimensions are in millimeters (mm) unless otherwise specified.

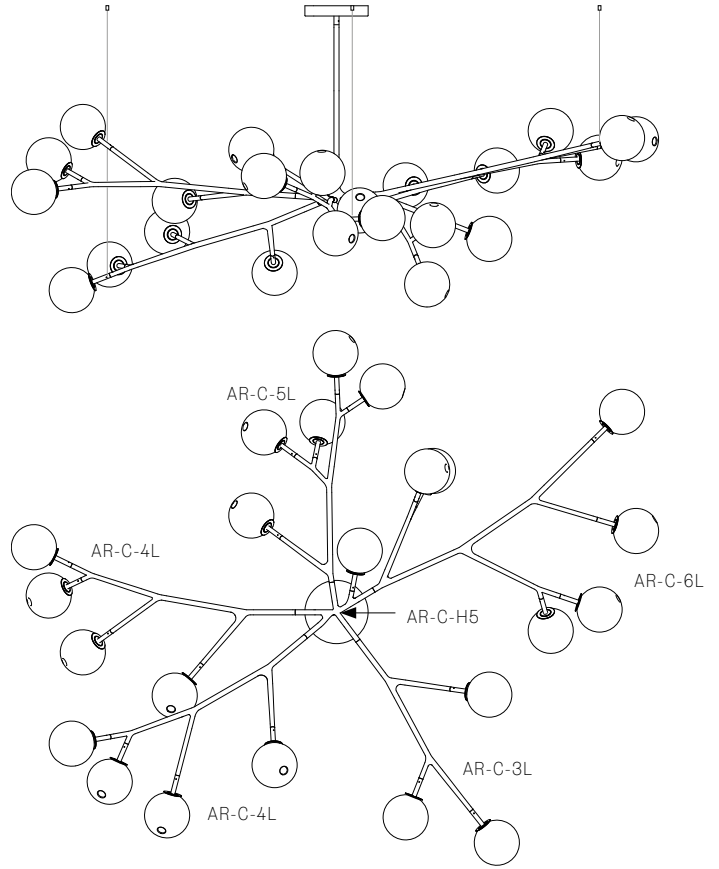
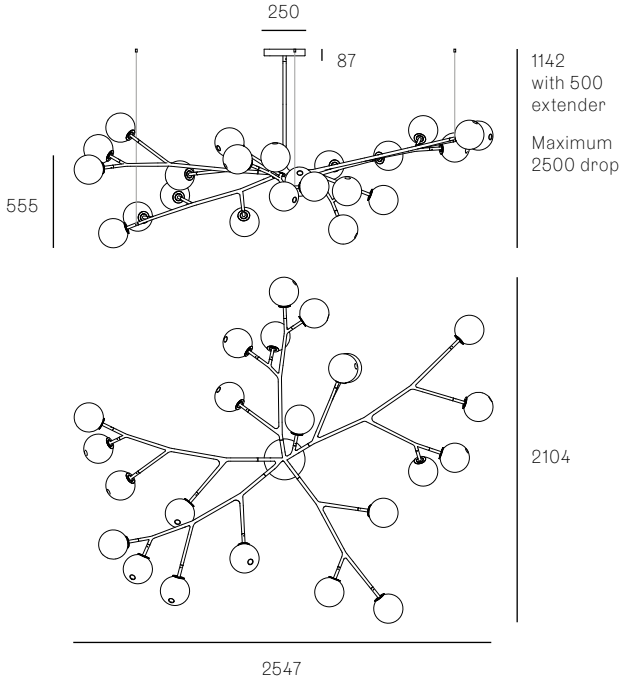

28.33A.1

