

FLEXFORM

MADE IN ITALY



> OUTDOOR COLLECTION

PICO OUTDOOR *DESIGN CENTER 2020*

TAVOLI TABLES

FLEXFORM Spa

Via Einaudi 23/25 20821 Meda (MB) Italy | Tel. +39 0362 3991 | Fax +39 0362 399228 | info@flexform.it | www.flexform.it

PICO OUTDOOR | DESIGN CENTER | 2020

TIPOLOGIE TAVOLI - TAVOLINI /CONSOLLE **PRODOTTO** TAVOLI - TAVOLINI - CONSOLLE **STRUTTURA** IN ACCIAIO INOX 316 VERNICIATO A FORNO CON POLVERI EPOSSIDICHE NEI COLORI BIANCO 100, ROSSO VINO 405, VERDE KAKI 705, BRUNITO, GRIGIO **PIANO** IN LEGNO MASSELLO DI IROKO NELLE FINITURE NATURALE, TINTO GRIGIO, LACCATO BIANCO. TIRANTI E VITI IN ACCIAIO INOX 316, DISTANZIALI IN ZAMA PRESSOFUSA VERNICIATI A FORNO CON POLVERI EPOSSIDICHE CON FINITURA TRASPARENTE O IN PIETRA NELLE TIPOLOGIE LAVICA, PORFIDO, CARDOSO, BEOLA ARGENTATA. PER LA PIETRA È PREVISTO UN SOTTOPIANO IN LEGNO MULTISTRATO VERNICIATO **GAMBE** IN ALLUMINIO PRESSOFUSO VERNICIATA A FORNO CON POLVERI EPOSSIDICHE NEI COLORI BIANCO 100, ROSSO VINO 405, VERDE KAKI 705, BRUNITO, GRIGIO. APPOGGIO A TERRA SU PUNTALI IN MATERIALE TERMOPLASTICO **COVER** IN MATERIALE IMPERMEABILE, LA COVER È A RICHIESTA CON SUPPLEMENTO DI PREZZO

CATEGORIES TABLES - COFFEE TABLES/CONSOLES **PRODUCT** TABLES - COFFEE TABLES/SIDE TABLES/CONSOLES **STRUCTURE** IN 316 STAINLESS STEEL, BURNISHED; OR, WITH EPOXY POWDER-COAT FINISH IN WHITE 100, WINE RED 405, KHAKI GREEN 705, OR GREY **TOP** IN SOLID IROKO WOOD WITH NATURAL FINISH, STAINED GREY OR LACQUERED WHITE FINISH. SUPPORTS AND SCREWS IN 316 STAINLESS STEEL, SPACERS IN DIE-CAST ZAMA EPOXY POWDER-COAT WITH TRANSPARENT FINISH OR IN THE FOLLOWING TYPES OF STONE: PORPHYRY, CARDOSO, LAVA STONE, BEOLA ARGENTATA (SILVERY GREEN GNEISS). THERE IS A PAINTED PLYWOOD UNDERPANEL ON THE STONE VERSIONS **LEGS** IN CAST ALUMINUM WITH BURNISHED OR EPOXY POWDER-COAT FINISH IN THE FOLLOWING COLORS: WHITE 100, WINE RED 405, KHAKI GREEN 705, OR GREY. FEET REST ON TIPS MADE OF THERMOPLASTIC MATERIAL **COVER** IN WATERPROOF MATERIAL; COVER IS UPON REQUEST, WITH UPCHARGE

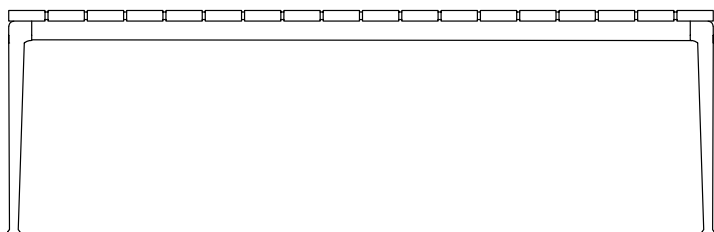





283L0

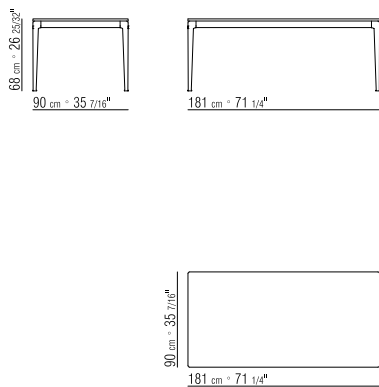

283L1

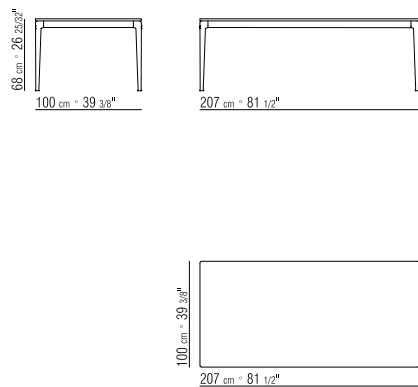

283L2

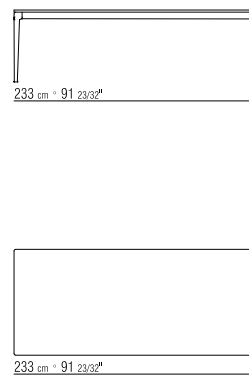

283L4

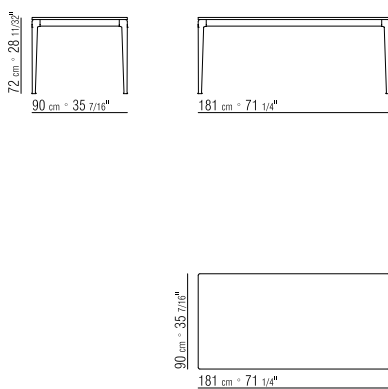

283L5

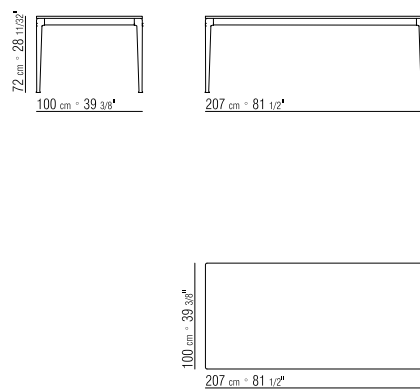

283L6

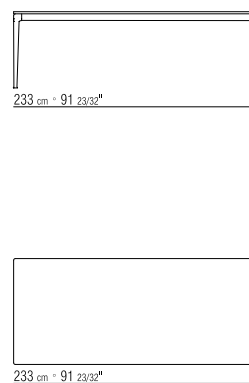

283M0

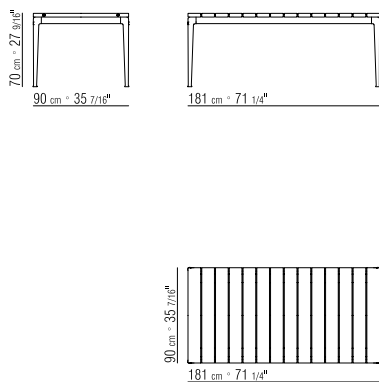

283M1

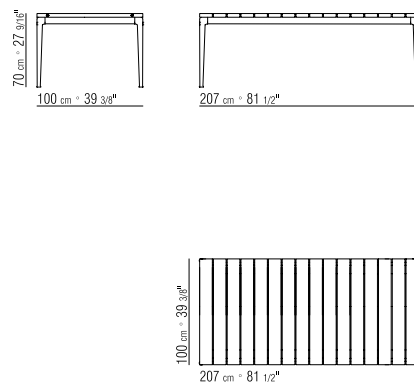

283M2

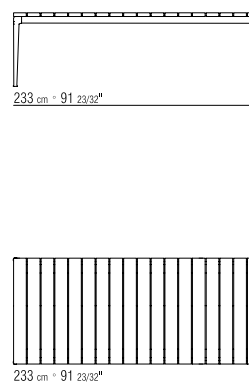

283M4

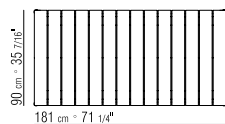
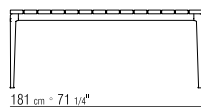
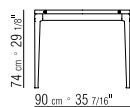

283M5

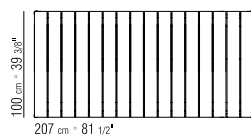
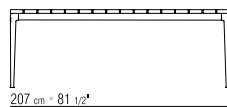
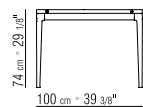

283M6

